

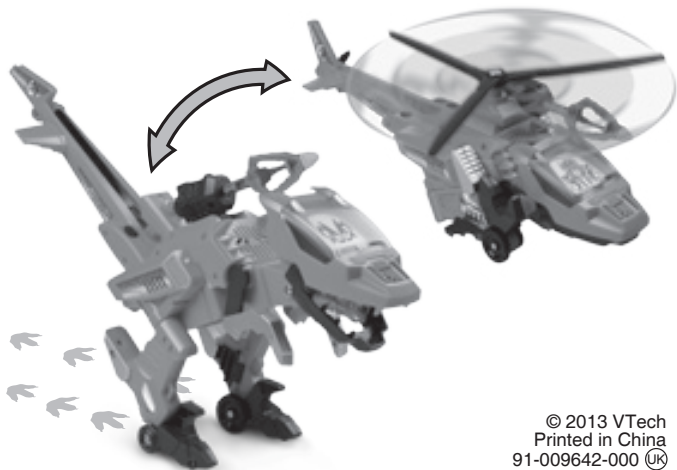

vtech®

User's Manual

**SWITCH&GO®**  
**DiNOS**   
*Commander Glade the Velociraptor*



© 2013 VTech  
Printed in China  
91-009642-000 

**VTech understands that a child's needs and abilities change as they grow and with that in mind we develop our toys to teach and entertain at just the right level...**

## **vtech** Baby

**Toys that will stimulate their interest in different textures, sounds and colours**

### **I am...**

...responding to colours, sounds and textures

...understanding cause and effect

...learning to touch, reach, grasp, sit-up, crawl and toddle

*Birth-36 months*



## **Pre-School**

**Interactive toys to develop their imagination and encourage language development**

### **I want...**

...to get ready for school by starting to learn the alphabet and counting

...my learning to be as fun, easy and exciting as can be

...to show my creativity with drawing and music so my whole brain develops

*3-6 years*

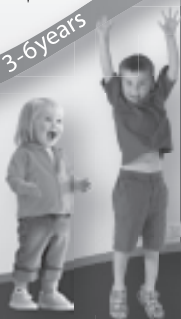

## **Electronic Learning Computers**

**Cool, aspirational and inspiring computers for curriculum related learning**

### **I need...**

...challenging activities that can keep pace with my growing mind

...intelligent technology that adapts to my level of learning

...National Curriculum based content to support what I'm learning at school

*4-10 years*



To learn more about this and other VTech® products, visit [www.vtechuk.com](http://www.vtechuk.com)

# INTRODUCTION

My name is **Commander Clade the Velociraptor**, and I'm looking for a few good dinos to join my squad. But let me warn you – you've got to be at your best to keep up with me! I'm fast and ferocious with sharp, curved claws that make me as tough as any dino.

I make a pretty tough helicopter too! I patrol the skies with my searchlight shining down from above. Once I've got a target in my sights, there's nowhere for it to hide!

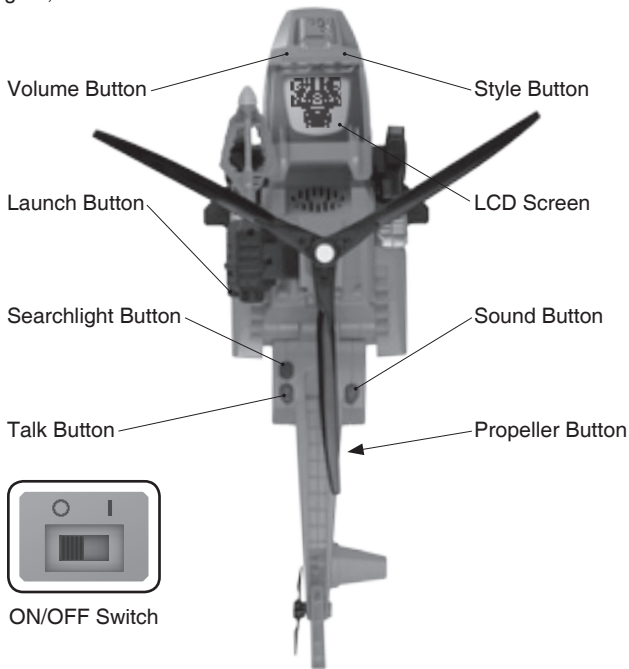

# INCLUDED IN THIS PACKAGE

- One VTech® SWITCH & GO DINOS®: Commander Clade the Velociraptor
- One user's manual

**WARNING:** All packing materials, such as tape, plastic sheets, packaging locks and tags are not part of this toy, and should be discarded for your child's safety.

**NOTE:** Please keep instruction manual as it contains important information.

## GETTING STARTED

### BATTERY INSTALLATION

1. Make sure the unit is turned **OFF**.
2. Locate the battery cover on the bottom of the unit. Use a screwdriver to loosen the screw.
3. Install 2 new AA (LR6/AM-3) batteries into the main unit following the diagram inside the battery box. (The use of new, alkaline batteries is recommended for maximum performance.)
4. Replace the battery cover and tighten the screw to secure.

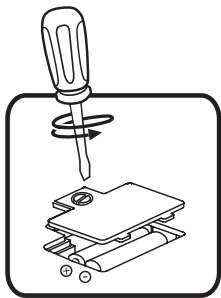

### BATTERY NOTICE

- Use new alkaline batteries for maximum performance.
- Use only batteries of the same or equivalent type as recommended.
- Do not mix different types of batteries: alkaline, standard (carbon-zinc) or rechargeable (Ni-Cd, Ni-MH), or new and used batteries.

- Do not use damaged batteries.
- Insert batteries with the correct polarity.
- Do not short-circuit the battery terminals.
- Remove exhausted batteries from the toy.
- Remove batteries during long periods of non-use.
- Do not dispose of batteries in fire.
- Do not charge non-rechargeable batteries.
- Remove rechargeable batteries from the toy before charging (if removable).
- Rechargeable batteries are only to be charged under adult supervision.

### Disposal of batteries and product



The crossed-out wheellie bin symbols on products and batteries, or on their respective packaging, indicates they must not be disposed of in domestic waste as they contain substances that can be damaging to the environment and human health.



The chemical symbols Hg, Cd or Pb, where marked, indicate that the battery contains more than the specified value of mercury (Hg), cadmium (Cd) or lead (Pb) set out in Battery Directive (2006/66/EC).

The solid bar indicates that the product was placed on the market after 13th August, 2005.

 Help protect the environment by disposing of your product or batteries responsibly.

For more information, please visit:

[www.recycle-more.co.uk](http://www.recycle-more.co.uk)

[www.recyclenow.com](http://www.recyclenow.com)

# PRODUCT FEATURES

## 1. TURNING THE UNIT ON

Slide the **ON/OFF** Switch to **ON** to turn the unit **ON**.



## 2. STYLE BUTTON

Press the **Style Button** to select the dino eyes you prefer in dino mode.

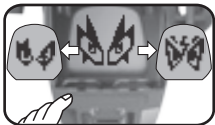

Press the **Style Button** to select the pilot you prefer in helicopter mode.

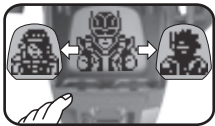

## 3. TALK BUTTON

Press the **Talk Button** to hear the dino or pilot talk.

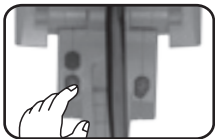

## 4. SOUND BUTTON

Press the **Sound Button** to hear cool sound effects.

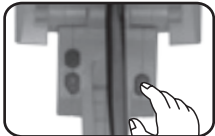

## 5. VOLUME BUTTON

Press the **Volume Button** to adjust the volume.

There are four levels available: low, medium, high, and mute.



## 6. SEARCHLIGHT BUTTON

Press the **Searchlight Button** to turn on the searchlight.



## 7. LAUNCH BUTTON

Press the **Launch Button** to launch the rocket.

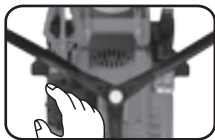

## 8. PROPELLER BUTTON

Press the **Propeller Button** to spin the propeller.



## 9. MOTION SENSOR

Move the helicopter through the air to hear fun flying sounds!

## 10. TURNING THE UNIT OFF/ AUTOMATIC SHUT-OFF

Slide the **ON/OFF** switch to **OFF** or hold the **Talk Button** for a few seconds to turn the unit **OFF**.

To preserve battery life, the unit will automatically power-off after several minutes without input.

## HOW TO SWITCH THE HELICOPTER TO A DINO

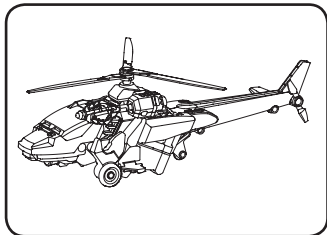

1. Helicopter shape.

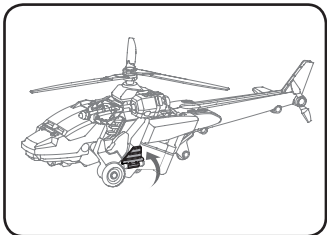

2. Fold the wings up.

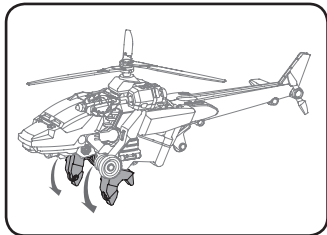

3. Turn the feet down.

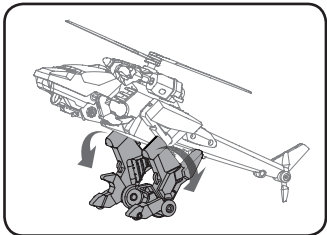

4. Flip the legs down.

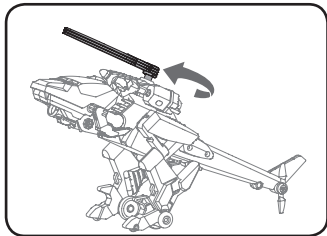

5. Fold up the propeller and turn it forward so that it's facing towards the dino's head.

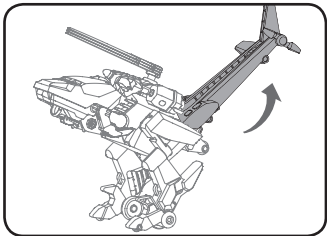

6. Lift the tail up as far as it will go.



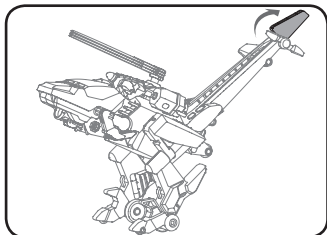

7. Turn the rear wing at the end of the tail back.

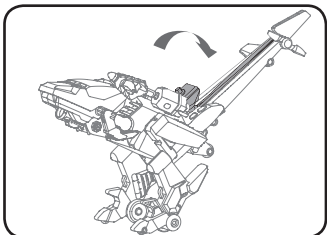

8. Flip the propeller down so that it rests within the tail.

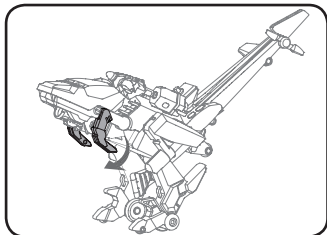

9. Unfold the arms.

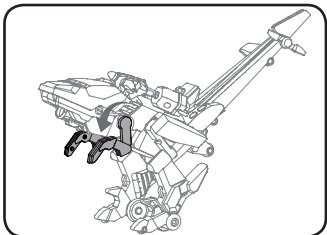

10. Move the arms down.

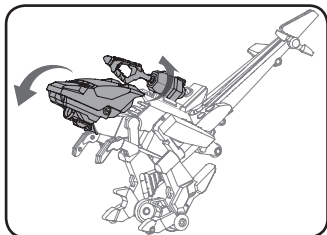

11. Move the head down and the rocket launcher up.

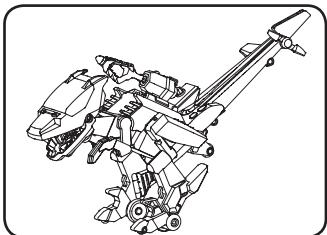

12. Dinosaur shape.

**Note:** To change the dino back into a helicopter, reverse the order of the steps above.

# CARE & MAINTENANCE

1. Keep the unit clean by wiping it with a slightly damp cloth.
2. Keep the unit out of direct sunlight and away from any direct heat source.
3. Remove the batteries when the unit is not in use for an extended period of time.
4. Do not drop the unit on hard surfaces and do not expose the unit to moisture or water.

# TROUBLESHOOTING

If for some reason the program/activity stops working or malfunctions, please follow these steps:

1. Please turn the unit **OFF**.
2. Interrupt the power supply by removing the batteries.
3. Let the unit stand for a few minutes, then replace the batteries.
4. Turn the unit **ON**. The unit should now be ready to play again.
5. If the product still does not work, replace with a new set of batteries.

If the problem persists, please call our Consumer Services Department on 01235 546810 (from UK) or +44 1235 546810 (outside UK) and a service representative will be happy to help you.

## **IMPORTANT NOTE:**

Creating and developing **VTech®** products is accompanied by a responsibility that we take very seriously. We make every effort to ensure the accuracy of the information which forms the value of our products. However, errors sometimes can occur. It is important for you to know that we stand behind our products and encourage you to call our Consumer Services Department on 01235 546810 (from UK) or +44 1235 546810 (outside UK) with any problems and/or suggestions that you might have. A service representative will be happy to help you.



CLASS 1  
LED PRODUCT



## PRODUCT WARRANTY



Thank you for choosing this quality product from VTech. We hope it will bring many hours of entertainment, imaginative play and learning.

1. The product detailed above is covered by a one year warranty from the date of purchase, against any defects in materials or workmanship.
2. The product may be returned to the place of purchase. Alternatively the product can be returned to VTech Electronics Europe plc (see address below), with proof of purchase, without proof of purchase no replacement will be provided.
3. VTech Electronics Europe plc will examine the product and if it is found to be defective due to faulty materials or workmanship, will replace the product at their discretion.
4. If the product covered by this warranty is damaged due to misuse, modification or unauthorised repair, or because of faulty batteries, battery discharge or incorrect electrical connections, then this warranty becomes void.
5. This warranty is personal to the original purchaser and is not transferable.
6. Breakages to the LCD screen are not covered by the warranty.
7. Returns to VTech Electronics Europe plc should include a cheque or postal order for £1.50 towards the cost of return postage and packaging.
8. Products returned to VTech Electronics Europe plc, should be addressed as follows and packed carefully to avoid damage in transit (Please do not include batteries or adaptor).  
Please include details of the fault together with your name and address.

VTech Electronics Europe plc, c/o Tablogix Limited, 200 Milton Park, Abingdon, Oxon OX14 4TA

**THIS WARRANTY IS OFFERED AS AN EXTRA BENEFIT AND DOES NOT AFFECT CONSUMERS' STATUTORY RIGHTS.**

This warranty is valid for the UK and Eire only. For products purchased outside the UK and Eire, please contact your local distributor or place of purchase.

